



# ACCESSORIES

## Every floor needs the right accessories

Accessories provide the perfect finishing touch to the look of the floor. They personalise and protect, and offer safety and signage features. Designed exclusively for the building industry, Tarkett's accessories range is a complete package of solutions to ensure that you have the right product, for the right place and at the right price. We also provide assistance with installation and customization on request.

Tarkett accessories can be used with all our heterogeneous and homogeneous vinyl and linoleum floorings. The range includes a wide variety of coordinating and contrasting colours and technical features, and is completed by our vinyl and linoleum welding rods.

Whether for decorative or practical purposes, the Tarkett accessories range is produced to the same high standards as our floors. Extensively tested by our product teams, every accessory is made to last as long as the floors they are used with. Like all Tarkett products, they are manufactured to meet the requirements of sustainability and environmental quality and use natural and renewable materials wherever possible.

Tarkett accessories meet all the current standards and regulatory requirements for safety and accessibility

Stair profiles	p. 318-319
Warning strips and signage	p. 320-321
Technical skirtings/ Cove formers	p. 322-325
Decorative skirtings	p. 326-329
Threshold strips and transition profiles	p. 330-335
Wetroom accessories	p. 336-341

# Stair profiles

## Stair nosings

BDC45  
NM1  
NM20  
NM45  
MS1

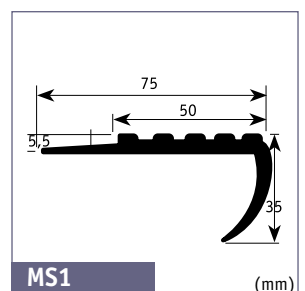
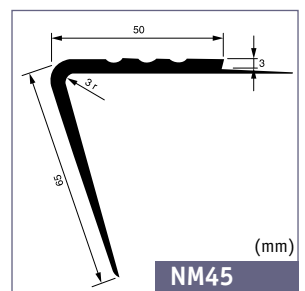
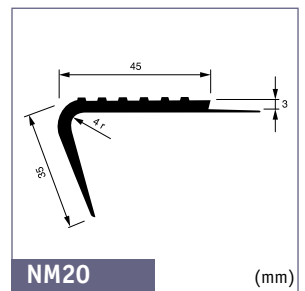
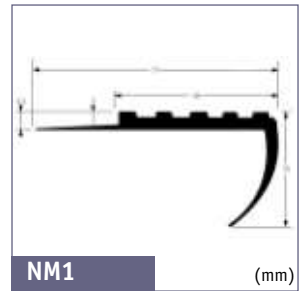
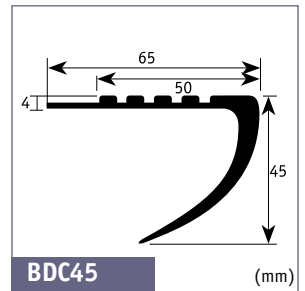

### BDC45/NM1/NM20/NM45

One piece slip-resistant soft PVC stair nosing. Cut to size on site and fixed with adhesive. Typically used with resilient floor coverings. Profile designs available to accommodate most stair shapes.

### MS1

Decorative metallic stair nose with long riser to be fixed over covered stairs and alongside platforms such as stands and podiums.

	BDC45	NM1	NM20	NM45	MS1
<b>Black</b> RAL: 1500 NCS: S 9000 N	-	1401 004	1404 004	1403 004	-
<b>Medium grey</b> RAL: 5000 NCS: S 5502 B	-	1401 005	1404 005	1403 005	-
<b>Light grey</b> RAL: 7500 NCS: S 3000 N	1400 004	1401 006	1404 006	1403 006	-
<b>Light beige</b> RAL: 070 80 10 NCS: S 2005 Y40R	-	1401 007	1404 007	1403 007	-
<b>Silver</b>	-	-	-	-	1434 001

SB1 - inside  
 SB2 - outside



**SB1/SB2**

Corners designed to form a neat and attractive edge around the open end of a step by concealing the edge of the floor covering and stair edging. Colour combination with soft PVC stair nosing by Tarkett.

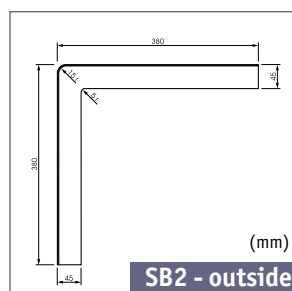
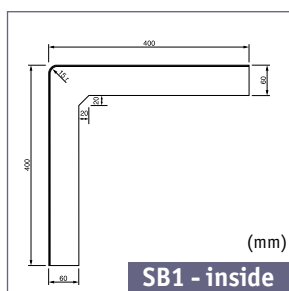

	SB1 inside	SB2 outside
<b>Black</b> RAL: 1500 NCS: S 9000 N	1432 004	1433 004
<b>Medium grey</b> RAL: 5000 NCS: S 5502 B	1432 005	1433 005
<b>Light grey</b> RAL: 7500 NCS: S 3000 N	1432 006	1433 006
<b>Light beige</b> RAL: 070 80 10 NCS: S 2005 Y40R	1432 007	1433 007

# Warning strip



### Tactile warning strips

Rubber tile with raised ribs that acts as a tactile warning surface for the visually impaired to recognize a change in level. The tile should contrast in colour with the surrounding floor covering to ensure clear visibility.

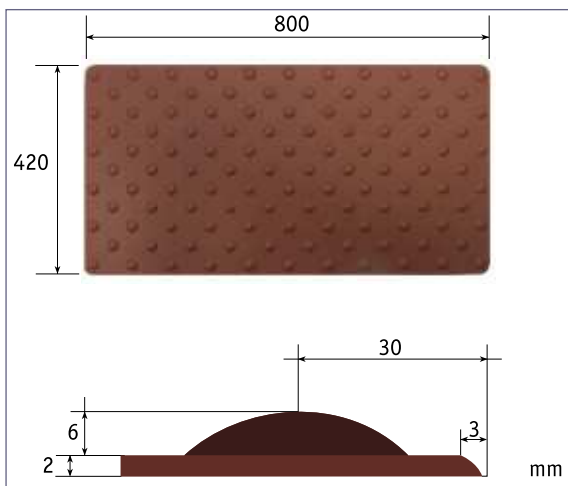

**WS1**

	<b>White</b> RAL: 9010 NCS: S 0500 N	1431 001
	<b>Black</b> RAL: 9004 NCS: S 8500 N	1431 002
	<b>Light grey</b> RAL: 7035 NCS: S 2002 G	1431 003
	<b>Beige</b> RAL: 1015 NCS: S 1010 Y20R	1431 004
	<b>Green</b> RAL: 6032 NCS: S 3060 G	1431 005
	<b>Yellow</b> RAL: 1033 NCS: S 1080 Y20R	1431 006
	<b>Red</b> RAL: 3003 NCS: S 2570 R	1431 007

**Signage**



**Signage**

Pictograms available on request, made out of resilient floor covering pieces.



# Wall base profiles

## Technical skirtings

**Corners**  
**PLS 100**  
**TC1/TC2**

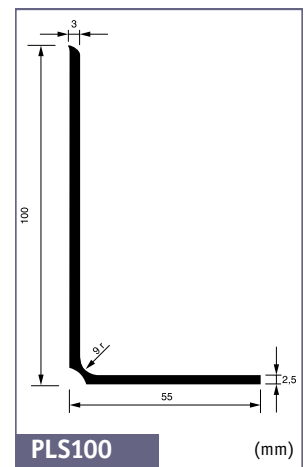

**PLS 100**  
 Flexible skirting to be welded with the floorcovering. Provides an impervious seal once welded to the floor covering. Ideal for critical clean areas.

**TC1/TC2**  
 Flexible corner covers to be welded with the floor covering and the associated skirtings. Provides an impervious seal once welded to the floor covering. Ideal for critical clean areas.

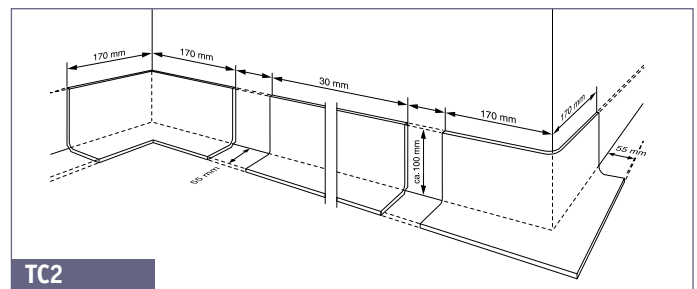
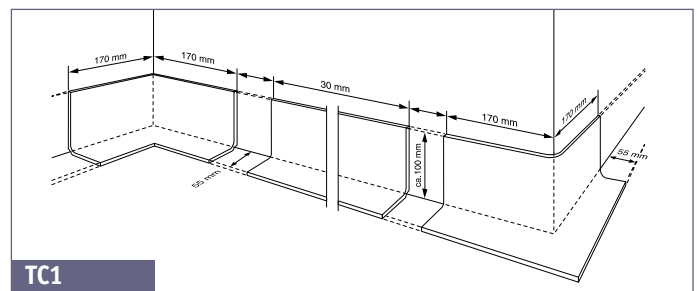

	PLS100	TC1	TC2
<b>Light brown/wood</b> RAL: 070 80 30 NCS: S 2020 Y 30 R	1410 009	1435 009	1436 009
<b>Black</b> RAL: 1500 NCS: S 9000 N	1410 010	1435 010	1436 010
<b>Medium grey</b> RAL: 5000 NCS: S 5502 B	1410 011	1435 011	1436 011
<b>Light grey</b> RAL: 7500 NCS: S 3000 N	1410 012	1435 012	1436 012
<b>Light beige</b> RAL: 070 80 10 NCS: S 2005 Y 40 R	1410 013	1435 013	1436 013
<b>White</b> RAL: 9003 NCS: S 0500 N	1410 014	1435 014	1436 014

## Feature Line FL







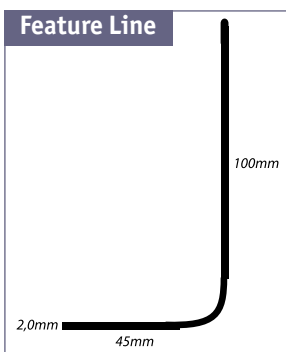





### Feature Line

Flexible skirting to be welded with the floor covering. Provides an impervious seal once welded to the floor covering. Ideal for critical clean areas



### FL

	<b>White</b> RAL: 9003 NCS: S 0500 N	1251 786		<b>Black</b> RAL: 3500 NCS: S 7502 B	1251 791
	<b>Dark green</b> RAL: 190 40 15 NCS: S 5030 B 50 G	1251 787		<b>Grey</b> RAL: 6000 NCS: S 4500 N	1251 792
	<b>Lilac</b> RAL: 360050 10 NCS: S 5010 R 30 B	1251 788		<b>Beige</b> RAL: 070 70 10 NCS: S 2010 Y 40 R	1251 793
	<b>Brown Yellow</b> RAL: 050 60 30 NCS: S 3030 Y 50 R	1251 789		<b>Blue</b> RAL: 260 40 20 NCS: S 5020 R 90 B	1251 794
	<b>Red</b> RAL: 030 40 40 NCS: S 3560 Y 80 R	1251 790		<b>Green</b> RAL: 160 60 10 NCS: S 4020 G 10 Y	1251 795

# Technical skirtings / Cove formers

Skirtings  
PAD8  
PAD10



### PAD8/PAD10

PVC profile which provides a neat cove allowing floor coverings to be dressed up the wall to form a skirting and support floor covering at a weak point. Capping seal to protect the exposed edge.

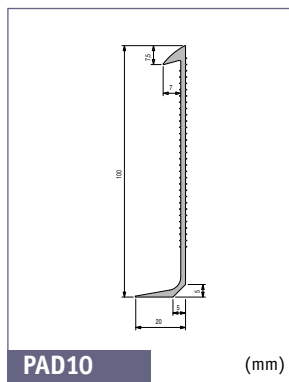
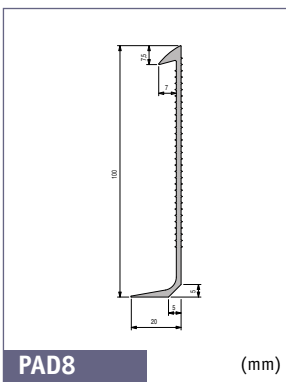

	PAD8	PAD10
<b>Medium grey</b> RAL: 5000 NCS: S 5502 B	1438 000	1437 000
<b>Light grey</b> RAL: 7500 NCS: S 3000 N	1438 001	1437 001
<b>White</b> RAL: 9003 NCS: S 0500 N	1438 002	1437 002

## Cove Formers PA20/PA30 CAP1/CAP2 CAP3

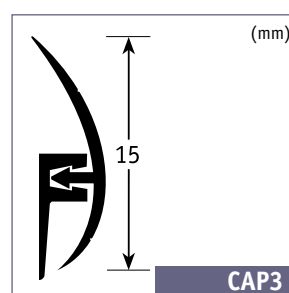
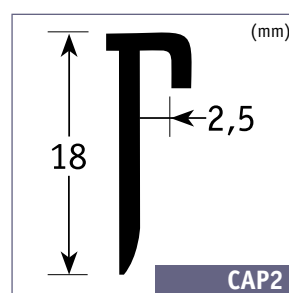
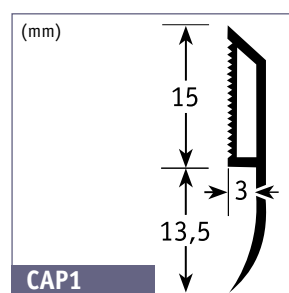
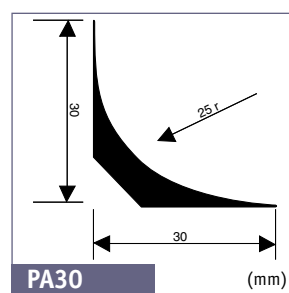
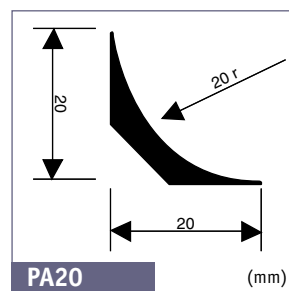

### PA20/PA30

Used to form a cove where floor coverings are continued up the wall. Usually used with a capping seal or cap to finish the raw edge of the floor covering.

### CAP1

Semi-flexible PVC capping seal used to finish the top of a resilient floor covering where it has been covered up the wall. Usually used with a cove former.

### CAP2

Self adhesive PVC capping seal used to finish the top of a floor covering where it has been covered up the wall. Usually used with a cove former.

### CAP3

Two-part PVC capping seal used to finish the top of a resilient floor covering where it has been covered up the wall. Usually used with a cove former.

	PA20	PA30	CAP1	CAP2	CAP3
<b>Medium grey</b> RAL: 5000 NCS: S 5502 B	1441 000	1442 000	1443 000	-	-
<b>Light grey</b> RAL: 7500 NCS: S 3000 N	-	-	1443 001	-	-
<b>White</b> RAL: 9003 NCS: S 0500 N	-	-	1443 002	1444 001	1445 001
<b>Black</b> RAL: 1500 NCS: S 9000 N	-	-	-	1444 000	1445 000
<b>Silver</b>	-	-	-	1444 002	-
<b>Wood colour matched</b> RAL: 070 80 30 NCS: S 2020 Y 30 R	-	-	-	-	1445 002

## Decorative skirtings

KS61  
S60/S100

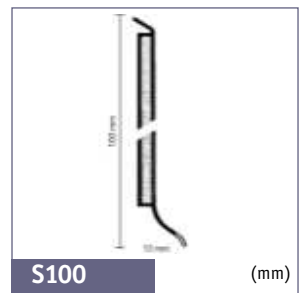
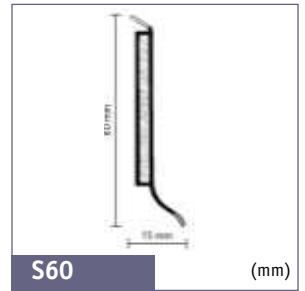
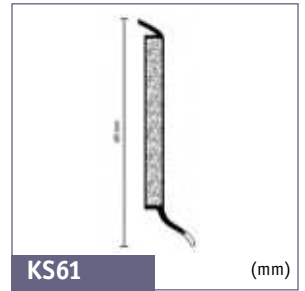

### KS61

Semi-rigid skirting for decorative use.

### S60/S100

Semi-rigid chlorine-free skirting for decorative use.



	KS61	S60	S100
<b>Black</b> RAL: 1500 NCS: S 9000 N	1411 007	1446 007	1447 007
<b>Dark grey</b> RAL: S 3500 N NCS: S 7502 B	1411 008	1446 008	1447 008
<b>Medium grey</b> RAL: 5000 NCS: S 5502 B	1411 009	1446 009	1447 009
<b>Grey</b> RAL: 6000 NCS: S 4000 N	1411 010	1446 010	1447 010
<b>Light grey 1</b> RAL: 7500 NCS: S 3000 N	1411 011	1446 011	1447 011
<b>Light grey 2</b> RAL: 8500 NCS: S 1500 N	1411 012	1446 012	1447 012
<b>Dark brown</b> RAL: 060 40 05 NCS: S 7005 Y 50 R	1411 013	1446 013	1447 013
<b>Dark red brown</b> RAL: 050 20 16 NCS: S 8010 Y 70 R	1411 014	1446 014	1447 014
<b>Dark yellow brown</b> RAL: 060 30 27 NCS: S 7020 Y 40 R	1411 015	1446 015	1447 015
<b>Red brown</b> RAL: 040 40 30 NCS: S 4040 Y 70 R	1411 016	1446 016	1447 016
<b>Terracotta</b> RAL: 050 30 30 NCS: S 6030 Y 70 R	1411 017	1446 017	1447 017
<b>Dark red</b> RAL: 040 30 40 NCS: S 3560 Y 80 R	1411 018	1446 018	1447 018
<b>Red</b> RAL: 030 40 60 NCS: S 1580 Y 90 R	1411 019	1446 019	1447 019
<b>Orange</b> RAL: 050 60 60 NCS: S 0570 Y 50 R	1411 020	1446 020	1447 020
<b>Beige 1</b> RAL: 070 60 20 NCS: S 4020 Y 20 R	1411 021	1446 021	1447 021
<b>Brown 1</b> RAL: 060 40 30 NCS: S 5030 Y 40 R	1411 022	1446 022	1447 022
<b>Brown 2</b> RAL: 060 50 30 NCS: S 4030 Y 30 R	1411 023	1446 023	1447 023
<b>Light brown</b> RAL: 060 60 30 NCS: S 3030 Y 40 R	1411 024	1446 024	1447 024
<b>Beige 2</b> RAL: 070 80 30 NCS: S 2020 Y 30 R	1411 025	1446 025	1447 025

	KS61	S60	S100
<b>Light beige</b> RAL: 070 80 10 NCS: S 3010 Y 50 R	1411 026	1446 026	1447 026
<b>Beige 3</b> RAL: 080 80 20 NCS: S 2010 Y 20 R	1411 027	1446 027	1447 027
<b>Yellow</b> RAL: 070 70 60 NCS: S 1060 Y 20 R	1411 028	1446 028	1447 028
<b>Purple red</b> RAL: 340 50 20 NCS: S 4030 R 30 B	1411 029	1446 029	1447 029
<b>Purple blue</b> RAL: 290 60 25 NCS: S 2040 R 60 B	1411 030	1446 030	1447 030
<b>Light purple</b> RAL: 290 60 10 NCS: S 3020 R 60 B	1411 031	1446 031	1447 031
<b>Grege</b> RAL: 060 60 10 NCS: S 3010 Y 50 R	1411 032	1446 032	1447 032
<b>Light green</b> RAL: 120 70 30 NCS: S 2030 G 40 Y	1411 033	1446 033	1447 033
<b>Medium green</b> RAL: 110 60 20 NCS: S 3020 G 40 Y	1411 034	1446 034	1447 034
<b>Blue green</b> RAL: 190 60 10 NCS: S 3020 B 50 G	1411 035	1446 035	1447 035
<b>Green yellow</b> RAL: 100 70 60 NCS: S 2050 G 70 Y	1411 036	1446 036	1447 036
<b>Dark blue 1</b> RAL: 250 30 10 NCS: S 7010 R 90 B	1411 037	1446 037	1447 037
<b>Blue 1</b> RAL: 250 50 25 NCS: S 3040 R 90 B	1411 038	1446 038	1447 038
<b>Dark blue 2</b> RAL: 270 40 25 NCS: S 5030 R 80 B	1411 039	1446 039	1447 039
<b>Blue 2</b> RAL: 260 60 25 NCS: S 2040 R 80 B	1411 040	1446 040	1447 040
<b>Medium blue</b> RAL: 250 50 20 NCS: S 4030 R 90 B	1411 041	1446 041	1447 041
<b>Light blue 1</b> RAL: 230 70 15 NCS: S 2020 B	1411 042	1446 042	1447 042
<b>Light blue 2</b> RAL: 260 70 15 NCS: S 2020 R 80 B	1411 043	1446 043	1447 043
<b>Green blue</b> RAL: 200 60 20 NCS: S 3030 B 50 G	1411 044	1446 044	1447 044

Wall base profiles  
**Decorative skirtings**

**LS 100**



**LS 100**

Fully glued linoleum on an aluminium support skirting.  
Production on request (approx. 1 month). Length: 2 lm.

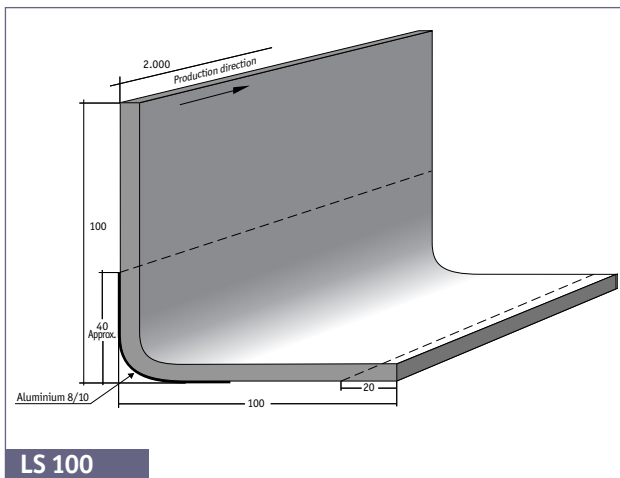

**LS 100**

1711 XXX for linoleum with 2.0 mm thickness  
1712 XXX for linoleum with 2.5 mm thickness  
1713 XXX for linoleum with 3.2 mm thickness

VS 100



**VS 100**  
Ventilated skirting made of wood. Different finishes available.  
On request.

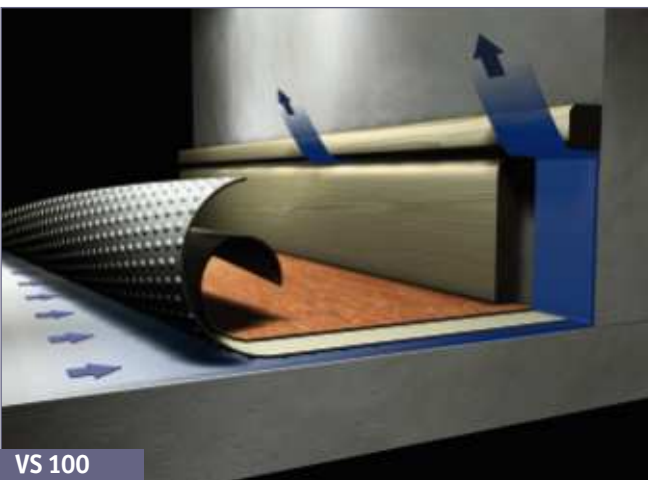

## Decorative skirtings

IS60



### IS 60

Semi-flexible skirting in which you can insert floor covering material.

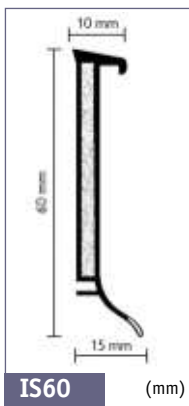

		IS60
	<b>Medium grey</b> RAL: 5000 NCS: S 5502 B	1448 000
	<b>Light grey</b> RAL: 7500 NCS: S 3000 N	1448 001
	<b>White</b> RAL: 9003 NCS: S 0500 N	1448 002

PL6  
PL8  
PL10



### PL6/PL8/PL10

Flexible skirting used where a neat and clean finishing is required in non critical areas. Typically adapted for social housing applications.

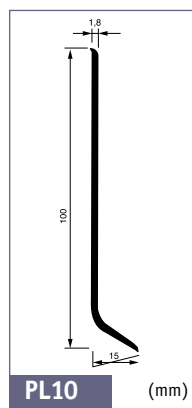
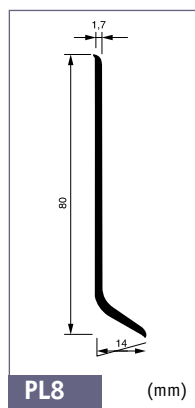
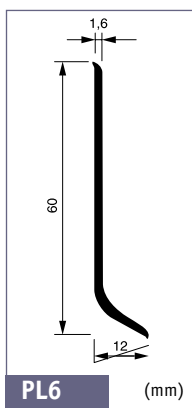

	PL6	PL8	PL10
<b>Matched to wood</b> RAL: 070 80 30 NCS: S 2020 Y 30 R	1449 000	1458 000	1450 000
<b>Black</b> RAL: 1500 NCS: S 9000 N	1449 001	1458 001	1450 001
<b>Dark grey</b> RAL: 5000 NCS: S 5502 B	1449 002	1458 002	1450 002
<b>Light beige</b> RAL: 070 80 10 NCS: S 2005 Y 40 R	1449 003	1458 003	1450 003
<b>Light grey</b> RAL: 7500 NCS: S 3000 N	1449 004	1458 004	1450 004
<b>White</b> RAL: 9003 NCS: S 0500 N	1449 005	1458 005	1450 005

## Threshold strips



### TMT

Metallic threshold strip which provides a transition between different flooring materials. Suitable for use in heavy traffic environments. Typically used at door thresholds.

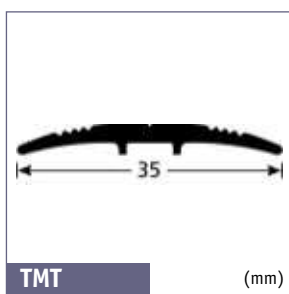

TMT	
	Silver 1451 000
	Bronze 1451 001

TTP



### TTP

One piece transition strip used to join different finishes of the same or slightly different heights.

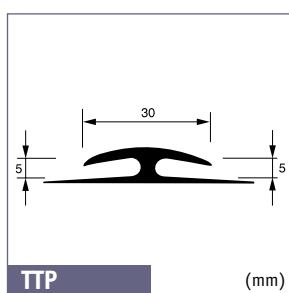

#### BDC45

Dark grey	RAL: 5000 NCS: S 5502 B	1452 000
Light grey	RAL: 7500 NCS: S 3000 N	1452 001
White	RAL: 9003 NCS: S 0500 N	1452 002



FT



**FT**  
 Bendable aluminium profiles used to form a join between different types of floor coverings.  
 Can be manually curved on site to accommodate shaped and radius designs.  
 Two heights available: one for compact floors and one for acoustic floors.

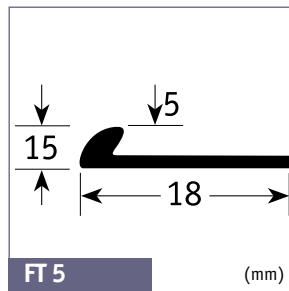
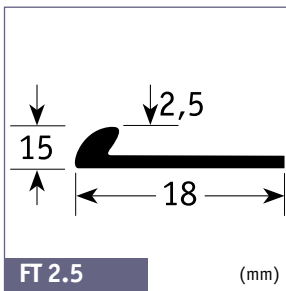

	FT 2.5 mm	FT 5.0 mm
Silver	1456 000	1456 001

# Cove formers and junction profiles

PA20/PA30  
PJ30

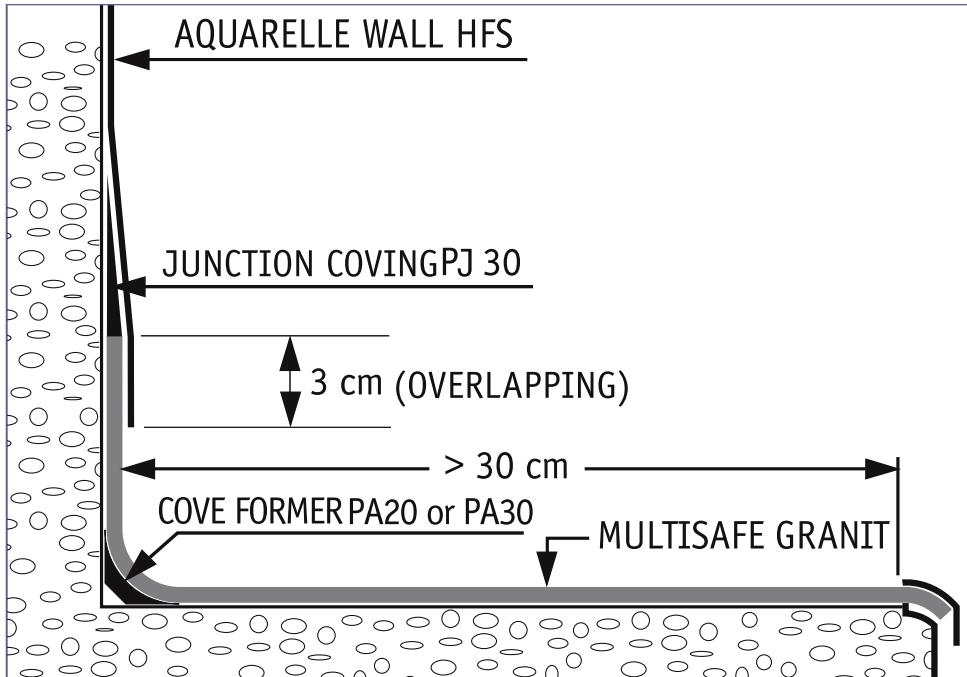

### PJ30

Transition profile for wall and floor junction.

### PA20/PA25

Used to form a cove where floor coverings are continued up the wall.

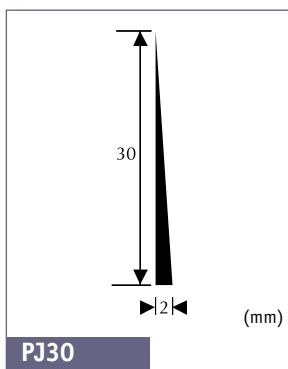

PJ30 1418 001

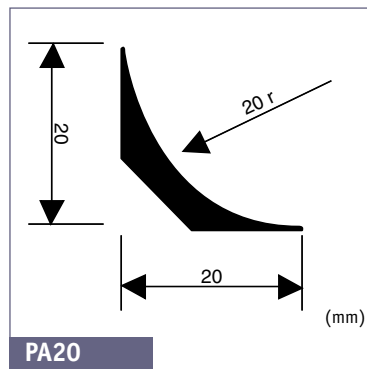

PA20 1441 000

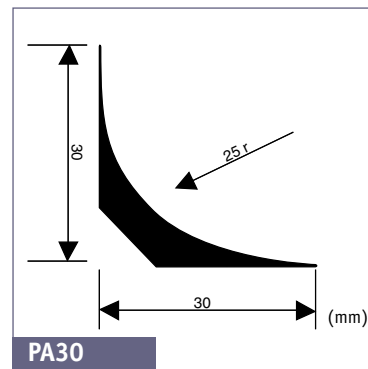

PA30 1442 000

**Purus siphons**

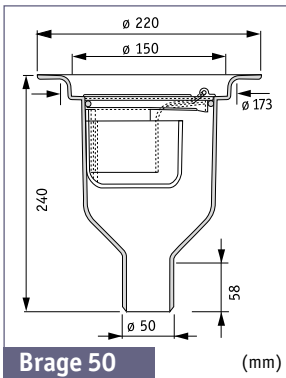

**Brage 50** (mm)  
 Diameter 50 1416 004

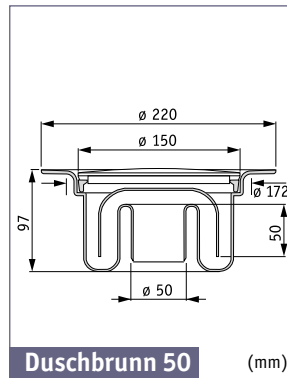

**Duschbrunn 50** (mm)  
 Diameter 50 1416 001

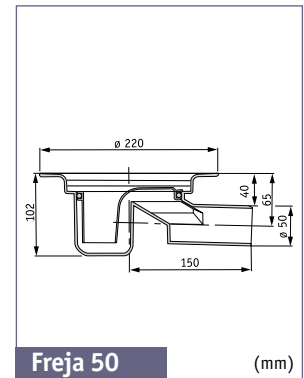

**Freja 50** (mm)  
 Diameter 50 1416 002

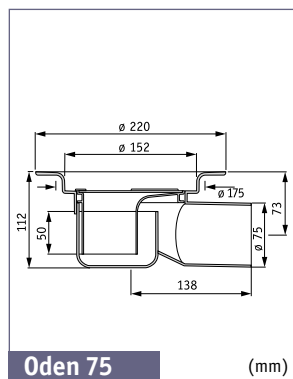

**Oden 75** (mm)  
 Diameter 75 1416 003

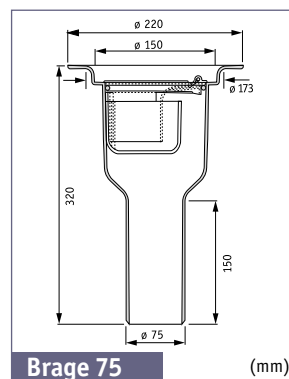

**Brage 75** (mm)  
 Diameter 75 1416 005

# Siphons spare items

Purus items

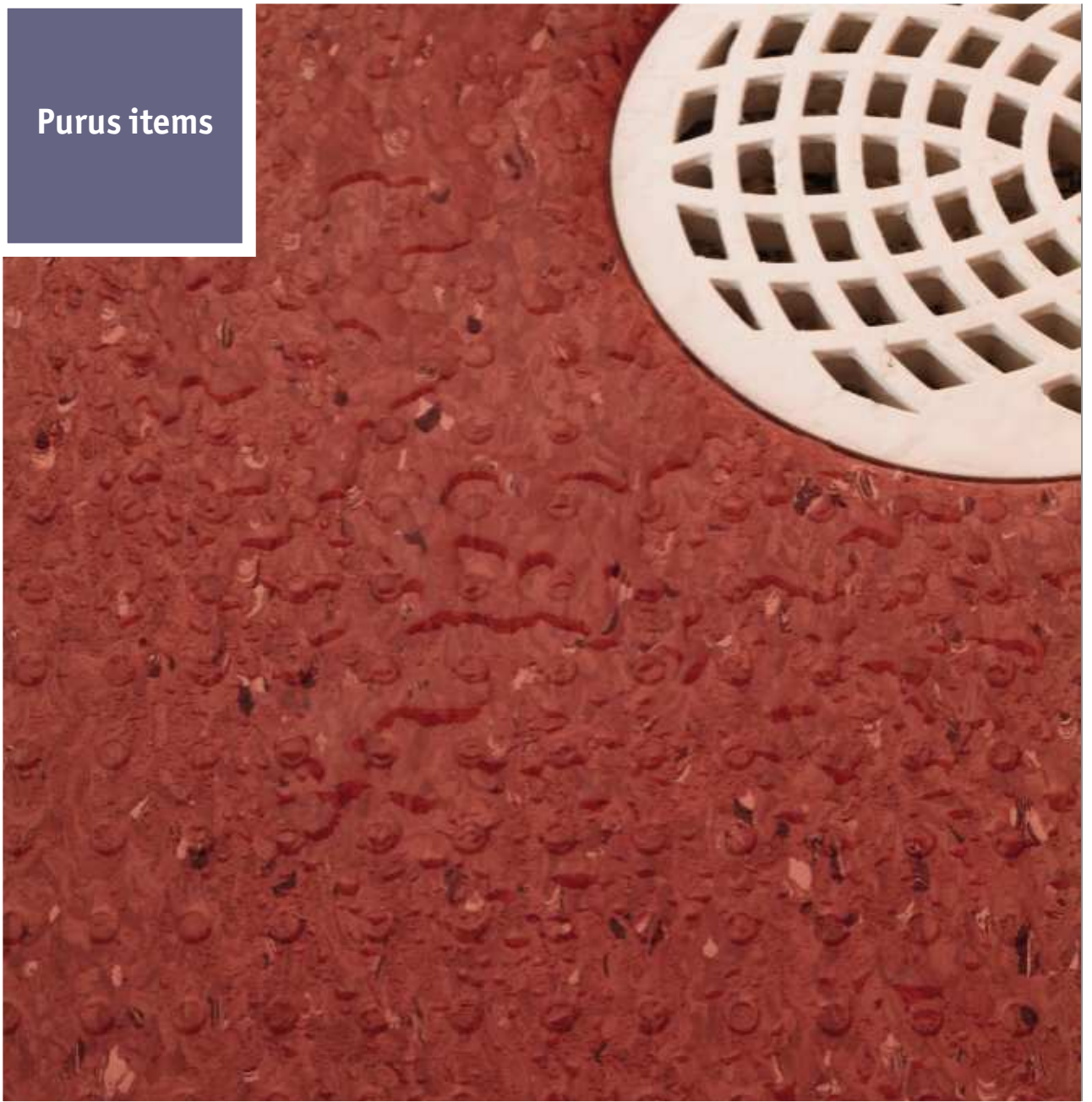

Grating

1417 001



Inox siphon

1416 007



Clamping ring

1417 002

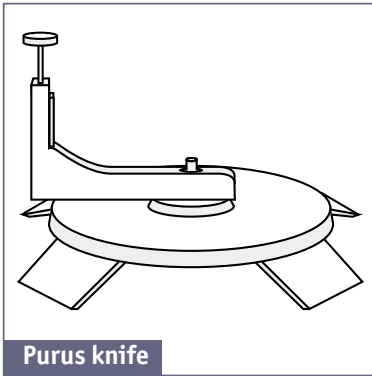

**Purus knife**

1417 003



**Support**

1417 004

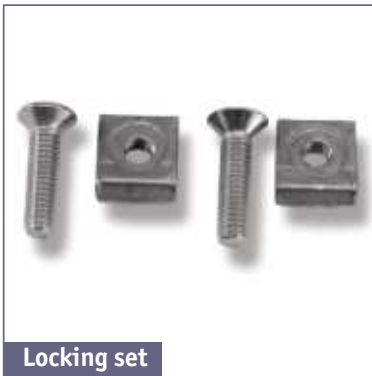

**Locking set**

1417 006



**Ran water trap**

1417 005



**Freja water trap**

1417 007



**Duschbrunn water trap**

1417 008

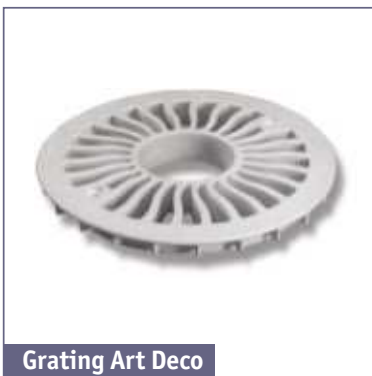

**Grating Art Deco**

1417 010



**Minimax**

1416 006

# Threshold strips

RTS



## RTS

Rubber transition profile for wet rooms.

Article code: 1255 748

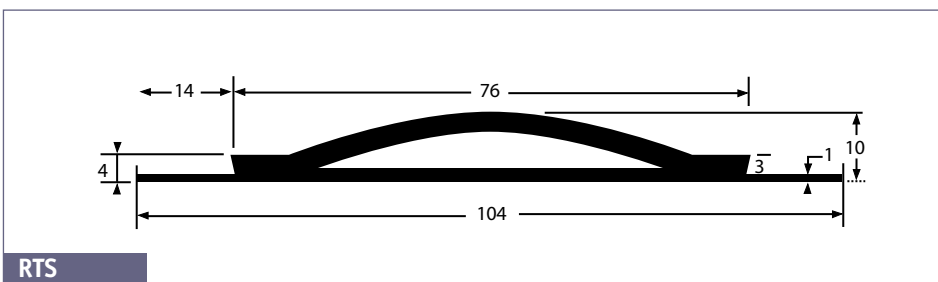

Sizes indicated in mm - Production tolerance  $\pm 0,3$  mm. Scale : 1 : 1.

**Stosett**



**Stosett low top and membrane**

Diameter*	Reference	Packaging
8 - 12 mm	1420 001	24 sleeves + 12 clamps
11 - 15 mm	1420 002	24 sleeves + 12 clamps
15 - 19 mm	1420 003	24 sleeves + 12 clamps
18 - 22 mm	1420 004	24 sleeves + 12 clamps
21 - 26 mm	1420 005	24 sleeves + 12 clamps
26 - 31 mm	1420 006	24 sleeves + 12 clamps
30 - 35 mm	1420 007	24 sleeves + 12 clamps
35 - 42 mm	1420 008	6 sleeves + 3 clamps
100 - 127 mm	1420 009	1 sleeve
Adhesive for Stosett	1260 021	1 tube = 160 ml

\* The first figure indicates the diameter of the upper part; the second indicates the diameter at the groove.